

## REPLACEMENT PARTS

To order parts, please give Part No., Description and Qty needed.

### EAGLE CLAW FISHING TACKLE

ATTN: Shappell Parts Dept.  
4245 E. 46th Ave., Denver, CO 80216

(720) 941-8723

### MODEL WH6500

Part#	Description
-------	-------------

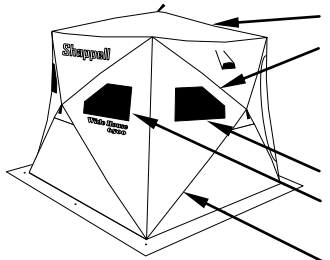

10538	Frame Rod Top (49-5/8")
10539	Frame Rod Top Side (47")
10527	Hub Plate
10528	Plastic Hub Insert
10532	Hub Body & Bolt & Strap
10555	Window - Right 12"H x 18"W
10536	Window - Left 12"H x 18"W
10541	Window - Door 12"H x 15"W
10540	Frame Rod Bottom Side (61")
IA2	Ice Anchor (pair)

### CONSUMER WARRANTY

Eagle Claw Shappell® warrants its products against defects in material and workmanship for one (1) YEAR from date of purchase. We will provide FREE repair or replacement, in whole or in part, at our option, for any product, found in our opinion to be defective. If return is required, freight must be prepaid. This warranty does not cover freight damage, ordinary wear and tear, abuse, misuse or altered product.

### WINDOWS ARE NOT GUARANTEED AT TEMPERATURES BELOW -15 DEGREES FAHRENHEIT.

For warranty claim, send letter indicating product and explanation of defect plus dated proof of purchase to Eagle Claw Fishing Tackle, ATTN: Warranty Dept., 4245 E. 46th Ave., Denver, CO 80216.

REV 0616

LOT #: \_\_\_\_\_

EAGLE CLAW  
**Shappell**

WIDE HOUSE 6500

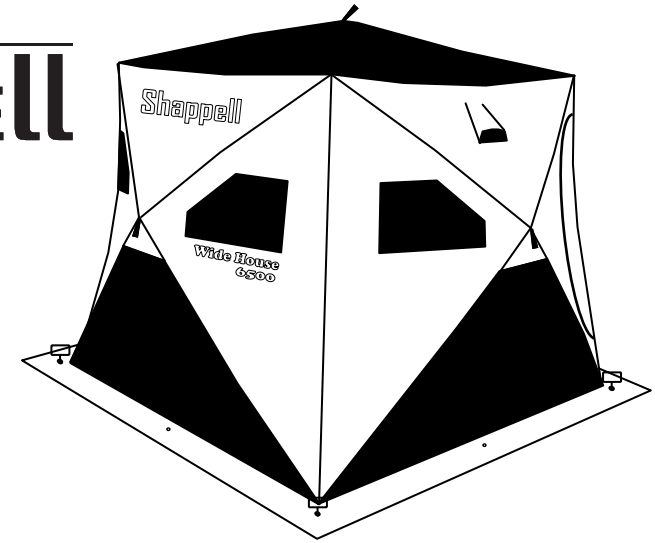

### IMPORTANT SAFETY INFORMATION



**WARNING: KEEP ALL FLAME AND HEAT SOURCES AWAY FROM THIS TENT FABRIC.** This tent meets the flammability requirements of CPAI-84. The fabric may burn if left in continuous contact with any flame source. The application of any foreign substance to the tent fabric may render the flame resistant properties ineffective.



**CARBON MONOXIDE POISONING HAZARD:** This shelter must be ventilated if using an oxygen consuming heat source. **DO NOT PACK SNOW AROUND SHELTER** or in any way prevent fresh air from entering shelter. **Failure to ventilate shelter could create a serious health hazard or death.**

Windows cannot be made to withstand temperatures below -15° F. (see warranty)

**MAINTENANCE:** After each use, set up shelter until fabric is completely dry. **Never leave shelter folded/closed with a wet cover.**

**NOTICE:** It is normal for fabric to have some pinholes. This does not affect water repellency.

**READ SETUP & TAKEDOWN INSTRUCTIONS BEFORE USING SHELTER**

## Set Up

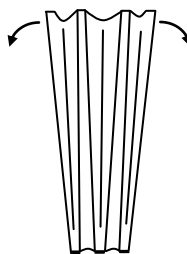

Fig. 1

1) Remove tent from bag and set hub end on ice. (Fig. 1)

2) Unfold tent and screw in ice anchor at one corner eyelet. (Fig. 2)

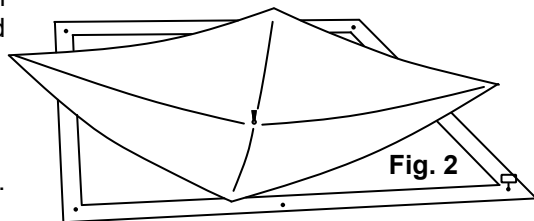

Fig. 2

3) Pull up on top hub or pull out side hub, whatever is easiest. (Fig. 3)

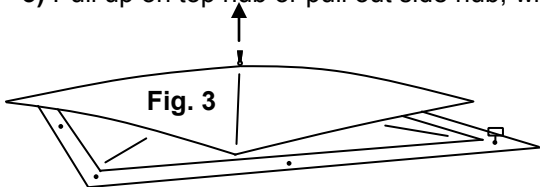

Fig. 3

4) Pull out side hub while pushing against top center. (Fig. 4)

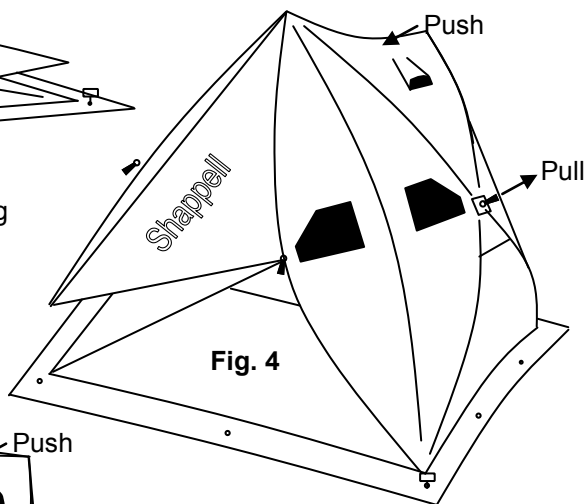

Fig. 4

5) Pull out all remaining hubs. (Fig. 5)

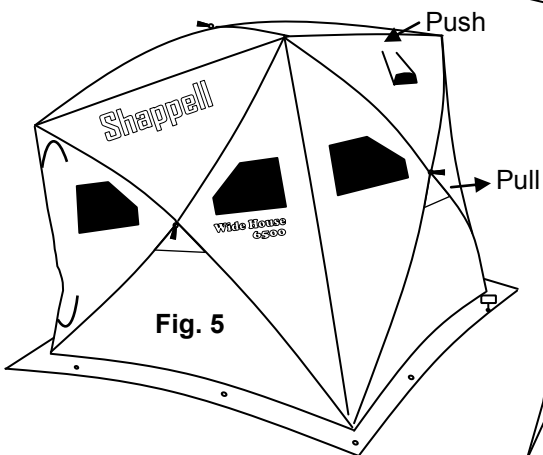

Fig. 5

6) Install remaining ice anchors as needed. (Fig. 6)

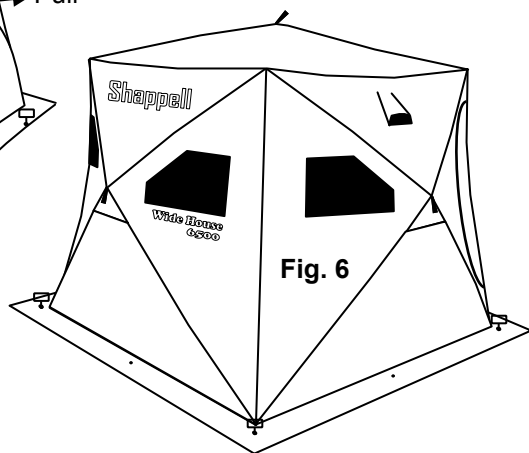

Fig. 6

## Take Down

1) Remove ice anchors, leaving one. Push in on side hub so it pops in. (Fig. 7)

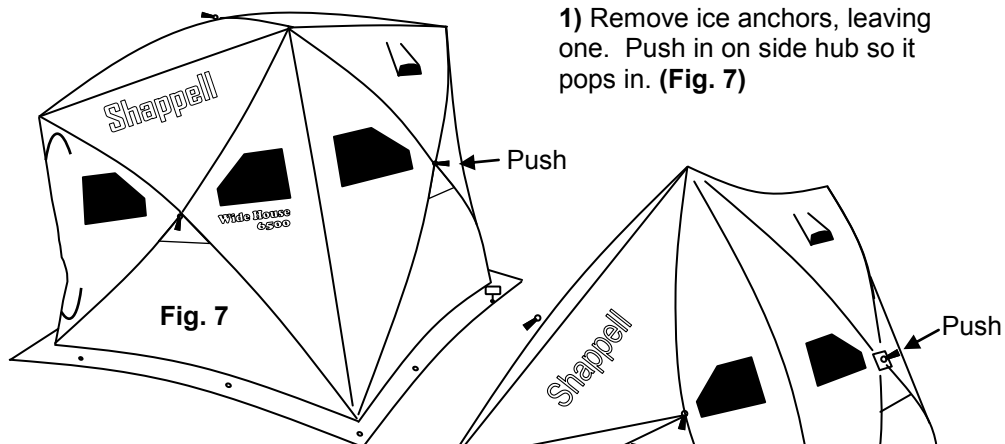

Fig. 7

2) Push remaining side hubs in. (Fig. 8)

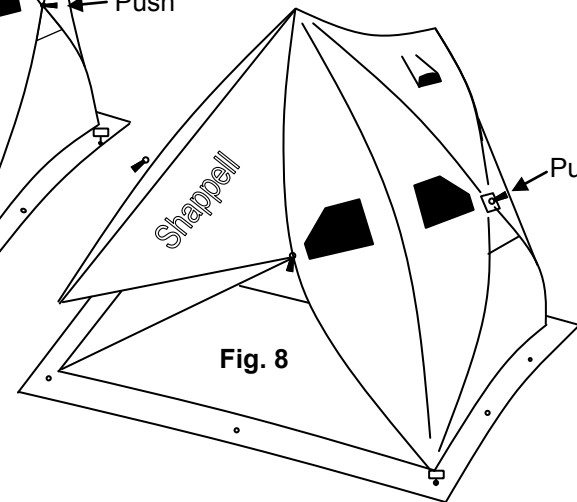

Fig. 8

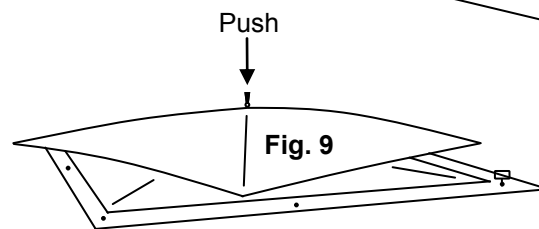

Fig. 9

3) Push top hub down. (Fig. 9)

4) Remove last ice anchor and fold all corners up. (Fig. 10) & (Fig. 11)

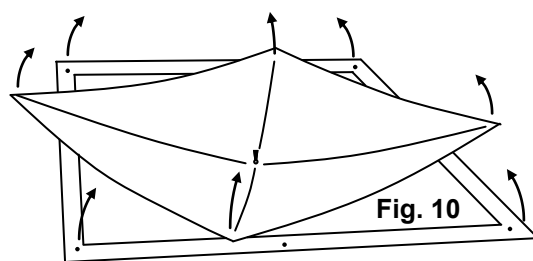

Fig. 10

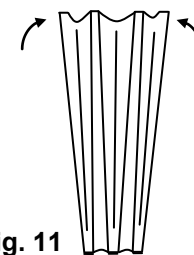

Fig. 11

5) Put tent into bag with hubs at the bottom of bag. (Fig. 12)

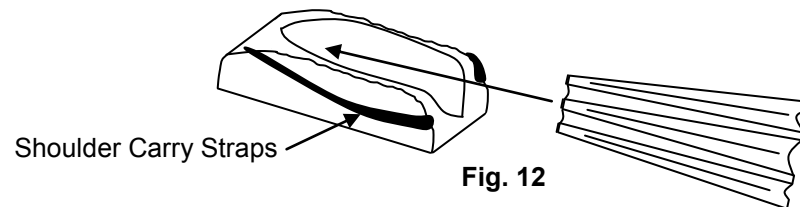

Fig. 12